



鑫 驰 翔

驰翔科技产品手册

CHIXIANG PRODUCT MANUAL

驰骋流体 翔领科技
CHI CHENG LIU TI XIANG LING KE JI

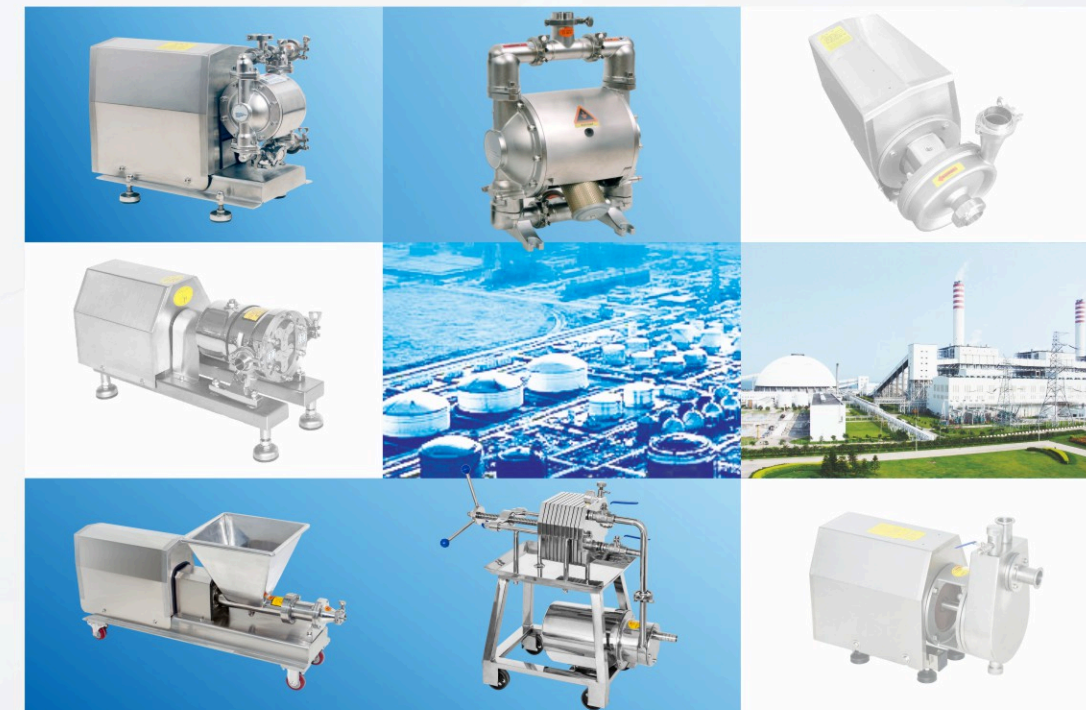

浙江驰翔科技有限公司
ZHEJIANG CHIXIANG TECHNOLOGY CO., LTD.

☎ 电话: 0577-8879 7328 13989753288

✉ 邮箱: 2929418330@qq.com

📍 地址: 浙江省温州市龙湾区永中街道榜眼桥南2幢3号

🌐 cxsci-tech.com

浙江驰翔科技有限公司
ZHEJIANG CHIXIANG TECHNOLOGY CO., LTD.

企业简介 → COMPANY PROFILE

浙江驰翔科技有限公司，坐落于充满创新活力的浙江省，自成立以来，始终专注于泵类产品的研发、生产与销售，凭借卓越的技术实力与严格的品质把控，在行业内迅速崛起，成为备受瞩目的优质企业。

公司产品种类丰富，尤其在不锈钢泵、过滤器产品领域成绩斐然，产品系列齐全，涵盖了不锈钢卫生级气动隔膜泵、电动隔膜泵、微形计量泵、螺杆泵、浓浆泵、卫生泵、离心泵、自吸泵、负压泵、转子泵、双螺杆泵、均质泵、不锈钢板框过滤器、袋式过滤器、硅藻土过滤器等产品。这些产品以其超群的品质，赢得了市场的广泛认可。

在技术研发方面，公司组建了一支由资深专家和专业技术人员构成的研发团队，他们密切关注行业前沿技术，不断探索创新，致力于提升产品性能和质量。通过持续的技术投入和创新实践，公司在不锈钢泵的设计和制造上掌握了多项核心技术，确保产品具备高效节能、稳定可靠、耐腐蚀、使用寿命长等诸多优势。

生产环节中，公司引进了国际先进的生产设备和自动化生产线，对原材料采购、生产加工、产品检测等各个环节进行精

细化管理和全程监控，从源头保障产品质量，每一台出厂的泵都经过严格检测，确保符合高质量标准。

公司产品广泛适用于食品、饮料、医药、化工、环保等多个重要领域。在食品和饮料行业，公司的不锈钢卫生级泵满足严格的卫生标准，保障产品安全与品质；医药领域，凭借高精度和稳定性，为药品生产提供可靠支持；化工行业中，耐腐蚀的特性使其能够应对各种复杂化学介质的输送；在环保领域，助力污水处理、水资源循环利用等项目，为环保事业贡献力量。

凭借卓越的产品品质和优质的服务，浙江驰翔科技有限公司已成为多家世界500强企业的供应商，与众多知名企业建立了长期稳定的合作关系，产品不仅畅销国内市场，还远销海外多个国家和地区，在国际市场上崭露头角。

未来，浙江驰翔科技有限公司将继续秉承“科技创新、品质至上、客户第一”的经营理念，不断加大研发投入，持续优化产品结构，提升服务水平，为全球客户提供更优质、更高效的泵类产品 and 解决方案，向着成为全球领先的泵类产品供应商的目标大步迈进，在行业发展的浪潮中书写更加辉煌的篇章。



Zhejiang Chixiang Technology Co., Ltd. is located in the innovative and dynamic Zhejiang Province. Since its establishment, it has always focused on the research and development, production, and sales of pump products. With excellent technical strength and strict quality control, it has rapidly risen in the industry and become a highly regarded high-quality enterprise.

The company has a wide range of products, especially in the field of stainless steel pumps and filters, with remarkable achievements. The product series is complete, covering stainless steel sanitary pneumatic diaphragm pumps, electric diaphragm pumps, micro metering pumps, screw pumps, slurry pumps, sanitary pumps, centrifugal pumps, self-priming pumps, negative pressure pumps, rotary pumps, twin-screw pumps, homogenization pumps, stainless steel plate and frame filters, bag filters, silicon bath soil filters and other products. These products have won widespread recognition in the market for their exceptional quality.

In terms of technological research and development, the company has established a research and development team composed of senior experts and professional technicians. They closely monitor cutting-edge technologies in the industry, constantly explore and innovate, and are committed to improving product performance and quality. Through continuous technological investment and innovative practices, the company has mastered multiple core technologies in the design and manufacturing of stainless steel pumps, ensuring that the products have many advantages such as high efficiency, energy saving, stability and reliability, corrosion resistance, and long service life.

In the production process, the company has introduced internationally advanced production equipment and automated production lines to carry out refined management and full

process monitoring of various links such as raw material procurement, production processing, and product testing, ensuring product quality from the source. Every pump leaving the factory undergoes strict testing to ensure compliance with high-quality standards.

The company's products are widely used in many important fields such as food, beverage, medicine, chemical industry, and environmental protection. In the food and beverage industry, the company's stainless steel sanitary pumps meet strict hygiene standards to ensure product safety and quality; In the pharmaceutical field, reliable support is provided for drug production with high precision and stability; In the chemical industry, its corrosion resistance enables it to handle the transportation of various complex chemical media; In the field of environmental protection, we assist in projects such as sewage treatment and water resource recycling, contributing to the cause of environmental protection.

With excellent product quality and high-quality service, Zhejiang Chixiang Technology Co., Ltd. has become a supplier to multiple Fortune 500 companies and established long-term stable cooperative relationships with many well-known enterprises. Its products are not only sold well in the domestic market, but also exported to multiple countries and regions overseas, and have made a name for themselves in the international market.

In the future, Zhejiang Chixiang Technology Co., Ltd. will continue to adhere to the business philosophy of "technological innovation, quality first, and customer first", continuously increase research and development investment, optimize product structure, improve service level, and provide global customers with higher quality and more efficient pump products and solutions. We will take big steps towards becoming a leading global pump product supplier and write a more brilliant chapter in the wave of industry development.

工艺流程 →

PROCESS FLOW DISPLAY



应用范围 →

APPLIED RANGE

适用于食品、饮料、制药、化妆品、洗涤、陶瓷、造纸、油墨、石油、化工、天然气、热力、船舶工业、电力、冶金、军工、建筑工程等领域。

It is applicable to the fields of food, beverage, pharmacy, cosmetics, washing, ceramics, paper making, printing ink, petroleum, chemical industry, natural gas, heat, shipbuilding industry, power, metallurgy, military industry, construction engineering, etc.

目录 CONTENTS

不锈钢气动隔膜泵06 Stainless steel pneumatic diaphragm pump	不锈钢自吸泵19 Stainless steel self-priming pump
不锈钢电动隔膜泵07 Stainless steel electric diaphragm pump	不锈钢卫生级自吸泵20 Stainless steel sanitary self-priming pump
不锈钢单螺杆泵08 Stainless steel single screw pump	卫生自吸负压泵21 Sanitary self-priming negative pressure pump
不锈钢双级螺杆泵09 Stainless steel two-stage screw pump	不锈钢回程泵25 Stainless steel return pump
不锈钢非标定制螺杆泵10 Stainless steel non-standard customized screw pump	不锈钢水粉混合机26 Stainless steel water powder mixer
不锈钢螺杆计量泵11 Stainless steel screw metering pump	不锈钢转子泵27 Stainless steel rotary pump
不锈钢单层圆盘过滤器12 Stainless steel single-layer disc filter	不锈钢乳化机29 Stainless steel emulsifier
不锈钢圆盘桶式过滤器12 Stainless steel disc bucket filter	不锈钢均质乳化泵30 Stainless steel homogeneous emulsion pump
不锈钢板框过滤器13 Stainless steel plate frame filter	不锈钢双螺杆泵31 Stainless steel twin-screw pump
不锈钢硅藻土过滤器14 Stainless steel silicon bath soil filter	不锈钢正弦泵33 Stainless steel sine pump
卫生级过滤器15 Sanitary grade filter	不锈钢胶体磨35 Stainless steel colloid mill
卫生级过滤器 (YL)16 Sanitary grade filter (YL)	卫生级不锈钢配件系列36 Sanitary grade stainless steel accessories series
不锈钢饮料泵17 Stainless steel beverage pump	卫生级阀门37 Sanitary valve
不锈钢离心泵18 Stainless steel centrifugal pump	卫生级卡箍、垫圈、活接头38 Sanitary grade clamps, washers, and flexible joints

不锈钢气动隔膜泵 Stainless Steel Pneumatic Diaphragm Pump



不锈钢气动隔膜泵
QBSY5-Φ63



不锈钢气动隔膜泵
QBSY5-Φ63



不锈钢气动粉体泵
QBSY5-Φ63

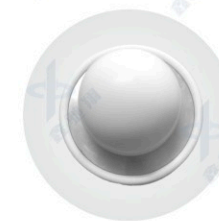

本公司生产QBSY5系列（不锈钢SUS304、316L）气动隔膜泵，是最新款的一种输送设备。采用压缩空气为动力源，对于各种腐蚀性液体，带颗粒的液体，高粘度、高浓度、易挥发、易燃、剧毒的液体，陶瓷釉浆，牛奶，蜂蜜，饮料，米酒，果酱，胶水，油轮仓库废油，污泥等液体均能抽光吸尽。无需灌引水，吸程最大可达7米，扬程可达84米。

出口压力 $\leq 0.8\text{MPa}$ ，流量可用气源来调节大小，无需用电，在易燃、易爆场所使用安全可靠，泵没有轴封，可以空转，超过负荷会自动停机，有自我保护功能，这是该泵的一大特点。

The company produces QBSY5 series (stainless steel SUS304, 316L) pneumatic diaphragm pumps, which are the latest transportation equipment. Compressed air is used as the power source to absorb all kinds of corrosive liquids, liquids with particles, high viscosity, high concentration, volatile, flammable and highly toxic liquids, ceramic glaze slurry, milk, honey, beverages, rice wine, jam, glue, waste oil from tanker warehouse, sludge and other liquids. There is no need for irrigation and water diversion. The maximum suction head can reach 7 meters and the lift can reach 84 meters.

The outlet pressure is $\leq 0.8\text{MPa}$, and the flow can be adjusted by the air source. No electricity is needed. It is safe and reliable to use in flammable and explosive places. The pump has no shaft seal and can run idle. If it exceeds the load, it will automatically stop. It has a self-protection function, which is a major feature of the pump.

技术参数 Technical Parameter

型号 Model	流量(t/h) flow	扬程(m) Lift	出口压力 Outlet Pressure	吸程(m) Suction head	最大允许颗粒直径 Maximum Allowable Particle Diameter	最大供气压力 Maximum Air Supply Pressure	最大空气消耗量 Maximum Air Consumption	重量(kg) Weight
QBSY5-19	0.1-1.8	0-50	0.6Mpa	4.5	2.5mm	0.6Mpa	12.7SCFM	10
QBSY5-25	0.1-1.8	0-50	0.6Mpa	4.5	2.5mm	0.6Mpa	12.7SCFM	10
QBSY5-32	0.1-6	0-50	0.7Mpa	4.5	3.2mm	0.75Mpa	23.66SCFM	22
QBSY5-38	0.1-6	0-50	0.7Mpa	4.5	3.2mm	0.75Mpa	23.66SCFM	22
QBSY5-38	0.1-8.8	0-50	0.7Mpa	4.9	5.48mm	0.75Mpa	28SCFM	27
QBSY5-51	0.1-8.8	0-50	0.7Mpa	4.9	5.48mm	0.75Mpa	28SCFM	27
QBSY5-51	0.1-12	0-50	0.7Mpa	5.48	5.48mm	0.75Mpa	32SCFM	33
QBSY5-63	0.1-12	0-50	0.7Mpa	5.48	5.48mm	0.75Mpa	32SCFM	33
QBSY5-76	0.1-22	0-50	0.7Mpa	5.48	6.3mm	0.75Mpa	32SCFM	69
QBSY5-89	0.1-22	0-50	0.7Mpa	5.48	6.3mm	0.75Mpa	32SCFM	69

不锈钢电动隔膜泵

Stainless steel electric diaphragm pump



本公司生产DBSY5系列（不锈钢SUS304、316L）电动隔膜泵，是一种新型的泵类。近年来，在隔膜材质上取得了突破性进展，膜片已完全达到了卫生级GB标准，国际上越来越多的工业化国家采用该种形式的泵，取代部分离心泵、螺杆泵，来应用于食品、饮料、蜂蜜、洗发水、石化、陶瓷、冶金、环保等行业。产品设计均参考国际品牌的理念，该泵适用于低压，即出口压力 $\leq 4\text{kgf/cm}^2$ 的场合，不需灌引水，自吸能达1-5米以上，通过性能好，直径在10毫米以下的颗粒、泥浆等可以毫无费力通过。

The company produces DBSY5 series (stainless steel SUS304, 316L) electric diaphragm pump, which is a new type of pump. In recent years, a breakthrough has been made in the diaphragm material. The diaphragm has completely reached the GB standard of sanitary grade. More and more industrialized countries in the world use this type of pump to replace some centrifugal pumps and screw pumps and apply it to food, beverage, honey, shampoo, petrochemical, ceramics, metallurgy, environmental protection and other industries. The product design refers to the concept of international brands. The pump is applicable to low pressure, that is, the outlet pressure $\leq 4\text{kgf/cm}^2$. It is unnecessary to irrigate and draw water. The self absorption energy is more than 1-5 meters, and the passing performance is good. Particles and mud with a diameter of less than 10 mm can pass through easily.

技术参数 Technical Parameter

型号 Model	流量(t/h) flow	功率(kw) Power	压力(mpa) Pressure (mpa)	颗粒(mm) Particles	吸程(m) Suction head
DBSY5-19	0.95	0.55	0.4	2.6	3
DBSY5-25	0.95	0.55	0.4	2.6	3
DBSY5-32	3.38	1.5	0.4	3.2	4
DBSY5-38	3.38	1.5	0.4	3.2	4
DBSY5-38	5.5	1.5	0.4	5.48	5
DBSY5-51	5.5	1.5	0.4	5.48	5
DBSY5-51	7.8	2.2	0.4	5.48	5
DBSY5-63	7.8	2.2	0.4	5.48	5
DBSY5-76	13.1	3	0.4	6.4	5
DBSY5-89	13.1	3	0.4	6.4	5

不锈钢单螺杆泵

Stainless steel single screw pump

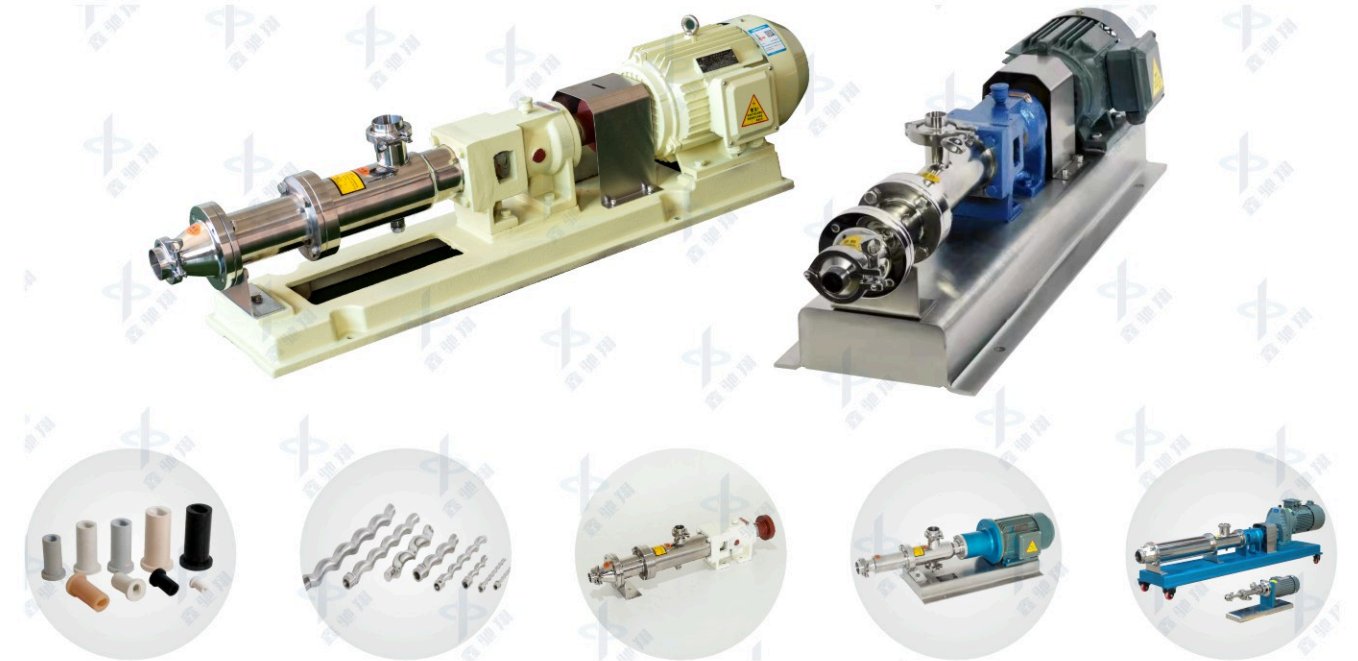

本公司生产的GR系列（不锈钢SUS304、316L）单螺杆泵，属容积式位移泵。该泵可用于输送中性腐蚀性液体，洁净的或磨损性的液体，含有气体或易产生气泡的液体，高粘度或低粘度的液体，包括含有纤维物和固体物质的液体，能吸真空状态下的物料，能长时间连续工作而保持平稳的流量，具有良好的自吸能力。广泛应用于食品、制药、纺织、造纸、石油、化工、造船、建筑、核能、冶金与采矿等行业。是输送领域的理想设备。

The GR series (stainless steel SUS304, 316L) single screw pumps produced by our company are displacement pumps. The pump can be used to transport neutral corrosive liquid, clean or abrasive liquid, liquid containing gas or easy to generate bubbles, high viscosity or low viscosity liquid, including liquid containing fiber and solid substances, can absorb materials under vacuum, can work continuously for a long time to maintain stable flow, and has good self-priming capacity. It is widely used in food, pharmacy, textile, paper making, petroleum, chemical industry, shipbuilding, construction, nuclear energy, metallurgy, mining and other industries. It is the ideal equipment in the transportation field.

技术参数 Technical Parameter

型号 Model	流量(m ³ /h) flow	电机功率(kw) Power	压力(mpa) Pressure (mpa)	转速(r/min) Rotating Speed	进出口口径 Diameter Of Inlet And Outlet
GR10-1	0.5	0.55	0.6	1400	25
GR15-1	1.5	0.55	0.6	960	25
GR20-1	1.8	0.75	0.6	960	32
GR25-1	2.5	1.1	0.6	960	32
GR30-1	3.5	1.5	0.6	960	38
GR35-1	6	2.2	0.6	960	51
GR39-1	7	2.2	0.6	960	51
GR40-1	6.5	2.2-8	0.6	710	51
	9	3	0.6	960	51
GR45-1	8.5	3-8	0.6	710	63
	12	4	0.6	960	63
GR50-1	12	4-8	0.6	710	89
	16	7.5-6	0.6	960	89
GR55-1	14	5.5-8	0.6	710	89
	18	7.5-6	0.6	960	89
GR60-1	21	5.5-8	0.6	710	89
GR65-1	30	7.5-8	0.6	710	102
GR70-1	40	11-8	0.6	710	125
GR85-1	60	15-8	0.6	710	150

不锈钢双级螺杆泵

Stainless steel two-stage screw pump

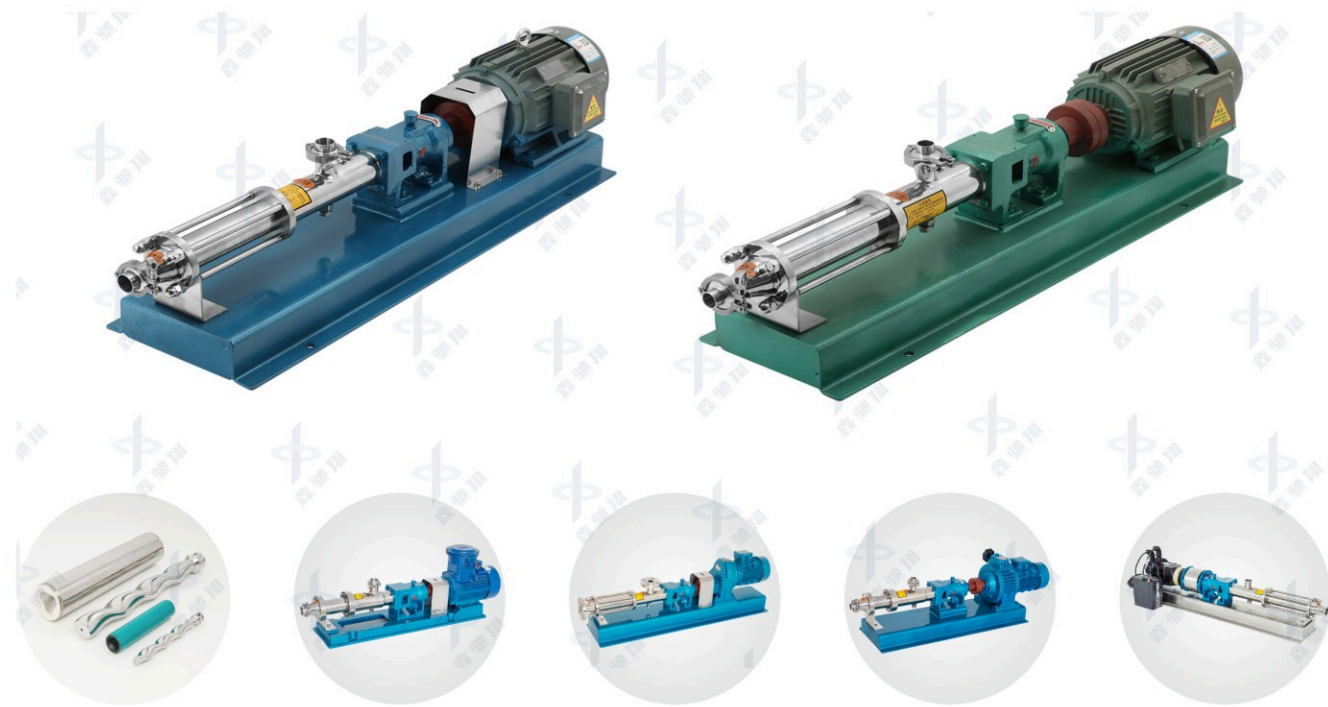

本公司生产的GR系列（不锈钢SUS304、316L）双级螺杆泵，属容积式位移泵。该泵可用于输送中性腐蚀性液体，洁净的或磨损性的液体，含有气体或易产生气泡的液体，高粘度或低粘度的液体，包括含有纤维和固体物质的液体，能吸真空状态下的物料，能长时间连续工作而保持平稳的流量，具有良好的自吸能力。广泛应用于食品、制药、纺织、造纸、石油、化工、造船、建筑、核能、冶金与采矿等行业。是输送领域的理想设备。

The GR series (stainless steel SUS304, 316L) two-stage screw pumps produced by our company are displacement pumps. The pump can be used to transport neutral corrosive liquid, clean or abrasive liquid, liquid containing gas or easy to generate bubbles, high viscosity or low viscosity liquid, including liquid containing fiber and solid substances, can absorb materials under vacuum, can work continuously for a long time to maintain stable flow, and has good self-priming capacity. It is widely used in food, pharmacy, textile, paper making, petroleum, chemical industry, shipbuilding, construction, nuclear energy, metallurgy, mining and other industries. It is the ideal equipment in the transportation field.

技术参数 Technical Parameter

型号 Model	流量(m ³ /h) flow	电机功率(kw) Power	压力(mpa) Pressure (mpa)	转速(r/min) Rotating Speed	进出口口径 Diameter Of Inlet And Outlet
GR10-2	0.5	0.55	1.2	960	25
GR15-2	1	1.1	1.2	960	25
GR25-2	2	2.2	1.2	960	32
GR30-2	3	3	1.2	960	38
GR35-2	5	3	1.2	960	51
GR40-2	12	5.5	1.2	960	63
GR50-2	15	7.5-8	1.2	710	89
GR65-2	30	11-8	1.2	710	102
GR70-2	40	15-8	1.2	710	125
GR85-2	60	18.5-8	1.2	710	150

不锈钢非标定制螺杆泵

Stainless steel non-standard customized screw pump



不锈钢卫生级螺杆泵
Stainless steel sanitary screw pump

不锈钢喂料移动式螺杆泵
Stainless steel two-stage screw pump

不锈钢喂料型螺杆泵
Stainless steel feeding screw pump

不锈钢喂料型调速螺杆泵
Stainless steel feeding speed regulating screw pump

不锈钢立式螺杆泵
Stainless steel vertical screw pump

不锈钢立式螺杆泵
Stainless steel vertical screw pump

不锈钢卫生级移动喂料型螺杆泵
Stainless steel sanitary movable feeding screw pump

不锈钢侧传动螺杆泵
Stainless steel side drive screw pump

不锈钢背包式螺杆泵
Stainless steel backpack screw pump

不锈钢螺杆泵配板框过滤器
Stainless steel screw pump with plate and frame filter

不锈钢圆斗式螺杆泵
Stainless steel circular bucket screw pump

不锈钢螺杆泵配袋式过滤器
Stainless steel screw pump with bag filter

■ 不锈钢螺杆泵非标定制，可来图来样，个性化设计加工，调试。

Stainless steel screw pump non-standard customization, can be drawn to sample, personalized design processing, debugging.

不锈钢螺杆计量泵

Stainless steel screw metering pump

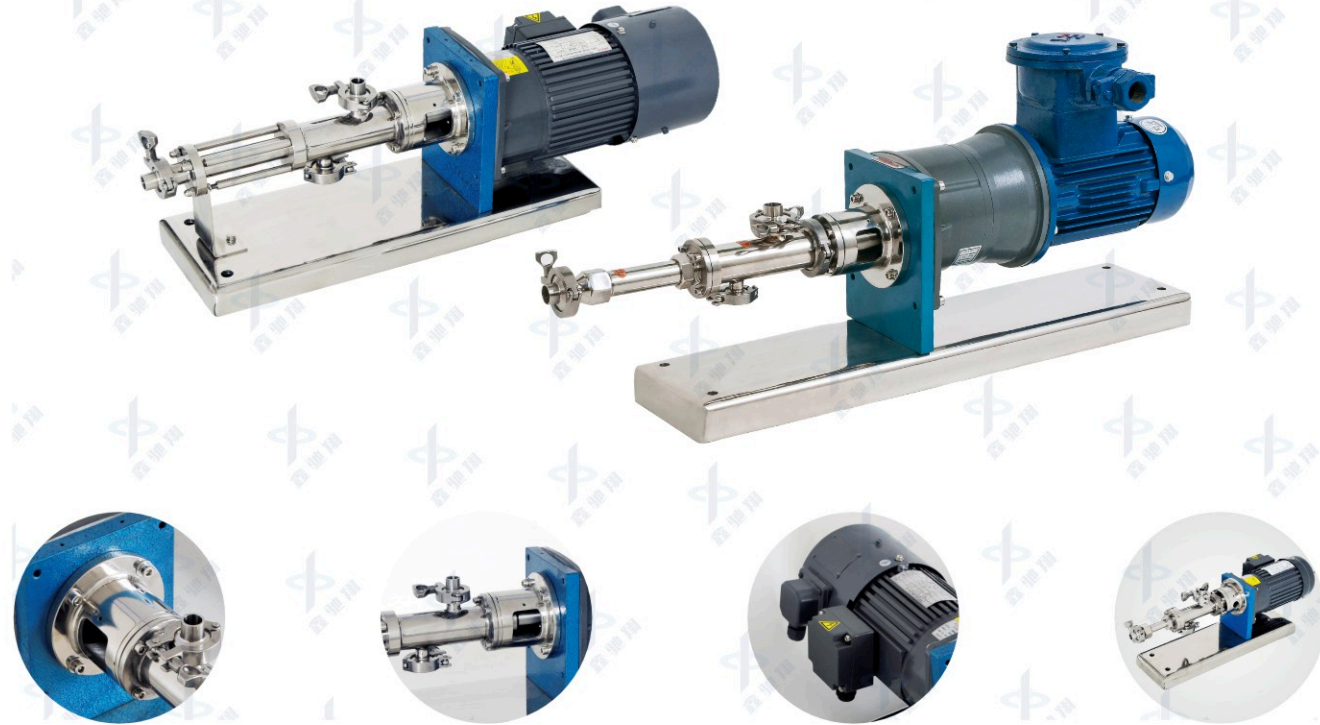

本公司生产的RV系列单螺杆计量泵，是一种内啮合回转式容积泵。定子、转子之间形成密闭腔，能连续的、匀速的、容积不变的将介质从吸入端输送到输出端，可以调整转速来控制流量，可作计量泵使用。自吸能力强、机械振动小、无脉冲。可输送粘稠、颗粒、纤维、流动性差、果酱、酒糟、絮凝剂、涂料等介质。可在真空负压情况下顺利将物料吸出，平稳的输送流量每小时 1L-2000L，压力0.1MPa~2.4MPa，精度达到±1%。

The RV series single screw metering pump produced by our company is an internal meshing rotary positive displacement pump. A sealed cavity is formed between the stator and rotor, which can continuously, uniformly and with constant volume transfer the medium from the suction end to the output end. The speed can be adjusted to control the flow, and it can be used as a metering pump. Strong self absorption, small mechanical vibration, no pulse. It can transport viscous, granular, fiber, poor fluidity, jam, lees, flocculant, paint and other media. The material can be suctioned out smoothly under vacuum and negative pressure. The stable conveying flow is 1L-2000L per hour, the pressure is 0.1MPa~2.4MPa, and the accuracy is ±1%.

技术参数 Technical Parameter

RV	电机功率(kw) Power	流量(100转) flow	流量(300转) flow	流量(460转) flow	压力(mpa) Pressure (mpa)
0.43	0.2	4.5	15.5	20.7	1.8
0.83	0.4	9	27	41.4	1.8
1.53	0.4	16.8	50.4	77.2	1.8
3.2	0.55	33.7	101	155	1.8
6.3	0.75	67.5	201	318	1.8
6.4	0.75	67.5	201	318	2.4
12.1	1.1	135	405	621	0.6
12.2	1.1	135	405	621	1.2
25.1	1.1	270	810	1242	0.6
25.2	1.5	270	810	1242	1.2

不锈钢单层圆盘过滤器

Stainless steel single-layer disc filter



本公司生产的DBG-1系列单层双层圆盘过滤器，采用SUS304、316L优质不锈钢制造，抗腐蚀、经久耐用，可广泛用于制药、食品、饮料、水处理、白酒、酿造、石油、化工、环保等行业。实验室、生产车间等，是各类液体进行过滤、澄清、提纯、除菌处理的最新设备。采用凸点式滤板，有效地增大了导水截面积，不同工艺生产（初滤、半精滤、精滤），可换不同孔径的滤膜一次性过滤，拆卸清洗方便。

The DBG-1 series single-layer and double-layer disc filters produced by our company are made of SUS304, 316L high-quality stainless steel, corrosion resistant, durable, and can be widely used in pharmaceutical, food, beverage, water treatment, Baijiu, brewing, petroleum, chemical, environmental protection and other industries. The laboratory and production workshop are the latest equipment for filtering, clarifying, purifying and sterilizing all kinds of liquids. The convex filter plate is used to effectively increase the water carrying area. Different production processes (primary filtration, semi fine filtration, fine filtration) can change the filter membrane with different pore diameters for one-time filtration. It is easy to disassemble and clean.

技术参数 Technical Parameter

型号 Model	滤板规格(mm) Filter Plate Specification	过滤孔径(μm) Filter Aperture	水流量(L/h) Water flow	过滤面积 (cm ²) Filter area	工作压力 (mpa) Working pressure	适用温度 (°C) Applicable temperature	滤器材质 Filter material
DBG-100	Φ100	0.1-50	50	58	0.15	5~100	304/316L
DBG-150	Φ150	0.1-50	100	135	0.15	5~100	304/316L
DBG-200	Φ200	0.1-50	180	255	0.15	5~100	304/316L
DBG-300	Φ300	0.1-50	420	575	0.15	5~100	304/316L
DBG-400	Φ400	0.1-50	700	1075	0.15	5~100	304/316L
DBG-500	Φ500	0.1-50	1000	1808	0.15	5~100	304/316L

不锈钢板框过滤器

Stainless steel plate frame filter



本公司生产的WBG-1系列板框式多层过滤器，采用SUS304、316L优质不锈钢制造，抗腐蚀、经久耐用，可广泛用于制药、食品、饮料、水处理、白酒、酿造、石油、化工、环保等行业。实验室、生产车间等，是各类液体进行过滤、澄清、提纯、除菌处理的最新设备。采用凸点式滤板，有效地增大了导水截面积，不同工艺生产（初滤、半精滤、精滤），可换不同孔径的滤膜一次性过滤，拆卸清洗方便。

The WBG-1 series plate and frame multilayer filters produced by our company are made of SUS304, 316L high-quality stainless steel, corrosion resistant, durable, and can be widely used in pharmaceutical, food, beverage, water treatment, Baijiu, brewing, petroleum, chemical, environmental protection and other industries. The laboratory and production workshop are the latest equipment for filtering, clarifying, purifying and sterilizing all kinds of liquids. The convex filter plate is used to effectively increase the water carrying area. Different production processes (primary filtration, semi fine filtration, fine filtration) can change the filter membrane with different pore diameters for one-time filtration. It is easy to disassemble and clean.

技术参数 Technical Parameter

型号 Model	层数 Number Of Layers	过滤面积 (m²) Filter area	滤材尺寸(mm) Filter material size	过滤介质(μm) Filter media	过滤压力(mpa) Filter pressure	水流量(t/h) Water flow	电机功率(kw) Motor Power	外形尺寸(mm) Overall dimension
WBG-100	10	0.078	Φ100	0.8	0.15	0.8	0.55	680*310*580
WBG-150	10	0.17	Φ150	0.8	0.15	1.5	1.1	780*350*700
WBG-200	10	0.34	Φ200	0.8	0.15	3	1.1	820*380*760
WBG-300	10	0.7	Φ300	0.8	0.15	5	1.5	920*500*900
WBG-400	10	1.25	Φ400	0.8	0.15	8	2.2	1260*600*1120
WBG-400	16	2	Φ400	0.8	0.15	9	3	1350*600*1150
WBG-400	20	2.5	Φ400	0.8	0.2	10	3	1420*600*1180
WBG-400	32	4	Φ400	0.8	0.3	12	3	1588*600*1180
WBG-400	40	5	Φ400	0.8	0.2	12	3	1708*600*1180
WBG-400	48	6	Φ400	0.8	0.2	12	3	1828*600*1180
WBG-500	10	1.96	Φ500	0.8	0.2	10	4	1350*720*1280
WBG-600	10	2.82	Φ600	0.8	0.2	12	5.5	1550*850*1480
WBG-200	10	0.4	200*200	0.8	0.15	3	1.1	820*380*760
WBG-300	10	0.9	300*300	0.8	0.15	6	1.1	920*500*900
WBG-400	10	2	400*400	0.8	0.15	10	1.5	1260*600*1120
WBG-400	20	3	400*400	0.8	0.15	12	2.2	1420*600*1180
WBG-400	26	4	400*400	0.8	0.2	15	2.2	1500*600*1180
WBG-400	32	5	400*400	0.8	0.2	18	2.2	1588*600*1180
WBG-400	38	6	400*400	0.8	0.3	21	2.2	1720*620*1200
WBG-400	44	7	400*400	0.8	0.3	23	3.0	1820*650*1250

不锈钢硅藻土过滤器

Stainless steel silica soil filter



本公司生产的WK系列硅藻土过滤器，该机已在白酒、果酒、低度酒、黄酒、药酒、葡萄酒和水处理等行业已广泛应用，过滤澄清度可达99.8%，操作得法，甚至可滤除大肠杆菌。能滤除1~0.1微米以下的微粒（包括微生物）。在实际使用中得到满意效果。我厂愿您在过滤工序中取得良好的效果而尽力，同时随时供应易损件等。机壳完全采用不锈钢SUS304、316L优质材料，结构紧凑，操作简便、体积小、重量轻、效率高、性能稳定、移动方便、过滤成本低、酒损少等特点。

The WK series silica soil filter produced by our company has been widely used in Baijiu, fruit wine, low alcohol wine, yellow rice wine, medicinal wine, wine and water treatment industries. The filtration clarity can reach 99.8%, and can even filter out Escherichia coli with proper operation. It can filter particles (including microorganisms) below 1~0.1 μm. The result is satisfactory in practical use. Our factory is willing to do our best for you to achieve good results in the filtering process, and supply vulnerable parts at any time. The casing is made of stainless steel SUS304 and 316L, featuring compact structure, simple operation, small volume, light weight, high efficiency, stable performance, convenient movement, low filtering cost, and less sprinkling loss.

技术参数 Technical Parameter

型号 Model	外形尺寸(mm) Overall dimension	过滤面积 (m²) Filter area	滤片数 (张) Number of filters	阀门口径 Valve diameter	理论数量以白酒为单位 Theoretical Quantity In Baijiu	工作压力 MPa Working Pressure	剂量(Kg) Dose	需配泵型号 Pump Model Required
Wk220	1100×350×450	1.1	15	DN25	0.5-2T/h	≤0.2	0.5-1	YL3-20
WK250	1100×350×450	2	20	DN25	1-3T/h	≤0.2	1-1.5	YL3-20
WK330-III	1600×600×750	2.5	15	DN32	2-4T/h	≤0.3	1.5-2	YL5-25
WK330-II	1700×600×750	3.4	20	DN32	3-5T/h	≤0.3	2.-2.5	YL5-25
WK400-I	1840×680×800	5.1	20	DN32	6-8T/h	≤0.3	2.5-3	YL10-25
WK400-A	2350×680×800	9.8	38	DN32	9-12T/h	≤0.3	4.5	YL20-25
WK500-B	1950×750×850	8.5	20	DN32	8-10T/h	≤0.3	3.5-4	YL20-25
WK500-A	2450×750×850	15.9	38	DN32	13-15T/h	≤0.3	5-6	YL20-25

卫生级过滤器

Sanitary Filter



微孔膜过滤器
Microporous membrane filter



袋式过滤器
Bag Filter



卫生级地漏
Sanitary floor drain



双联过滤器
Duplex filter



卫生级呼吸器
Sanitary rebreather



组合式过滤器
Combined filter

卫生级过滤器 (YL)

Sanitary Filter (YL)



卫生级视镜灯带雨刷
Sanitary mirror lamp with wiper



卫生级视镜灯
Sanitary mirror lamp



卫生级活接头视镜带雨刷
Sanitary union mirror with wiper



卫生级视镜
Sanitary mirror



Y 型过滤器
Y type filter



Y 型过滤器
Y type filter



双联管式过滤器
Double tube type filter



角式管道过滤器
Angle type pipeline filter



快装管式过滤器
Quick pipe filter



卫生级麦汁过滤器
Sanitary wort filter

■ 本公司生产各类微孔过滤器、钛棒过滤器、袋式过滤器等，可来图来样非标定制。
The company produces all kinds of microporous filters, titanium rod filters, bag filters, etc., can be customized to the drawing and sample.

■ 本公司生产各类不锈钢视镜、视灯、管道过滤器等，可来图来样非标定制。
The company produces all kinds of stainless steel mirror, light, pipe filter, etc., can come to the drawing to sample non-standard customization.

不锈钢饮料泵

Stainless steel beverage pump



本公司生产的BAW系列饮料泵、离心泵、单级离心泵、卫生泵，采用不锈钢SUS304、316L材质生产加工而成，适用于输送牛奶、饮料、酒等各类液体，是食品、医药、化工等行业不可缺少的输送设备。单机封使用最高温度为120℃左右，双机封使用最高温度为150℃左右，其中高扬程特别适用于管式杀菌、酸奶恒温设备。

The BAW series beverage pumps, centrifugal pumps, single suction centrifugal pumps and sanitary pumps produced by our company are made of stainless steel SUS304 and 316L. They are suitable for conveying all kinds of liquids such as milk, beverage and wine. They are indispensable conveying equipment in food, medicine, chemical industry and other industries. The maximum temperature of single seal is about 120 °C, and the maximum temperature of double seal is about 150 °C. The high lift is especially suitable for tubular sterilization and yogurt thermostatic equipment.

技术参数 Technical Parameter

型号 Model	电机功率(kw) Power	扬程(m) Lift	流量(m ³ /h) flow	进口管径(mm) Inlet Pipe Diameter	出口管径(mm) Outlet Pipe Diameter
BAW1-8	0.37	8	1T	32	25
BAW3-16	0.75	16	3T	38	32
BAW5-24	1.5	24	5T	38	32
BAW5-32	2.2	32	5T	51	38
BAW10-24	2.2	24	10T	51	38
BAW10-36	3	36	10T	51	51
BAW15-24	3	24	15T	51	51
BAW15-36	4	36	15T	51	51
BAW20-24	4	24	20T	63.5	51

注：本系列1T/h至10T/h可提供单相220V (0.37kw-2.2kw) 其余三相380V;下单时请先与我们确认电压，相数，以免不符，无法使用。
Note: 1T/h to 10T/h of this series can provide single-phase 220V (0.37kw-2.2kw) and its residual three-phase 380V; Please confirm the voltage and phase number with us before placing an order, so as to avoid inconsistency and failure to use.

不锈钢离心泵

Stainless steel silica soil filter



适用于输送牛奶、豆浆、果汁饮料、酒等各类液体食品。
It is Suitable For Conveying Milk, Soybean Milk, Fruit Juice Drinks, Wine And Other Liquid Foods.

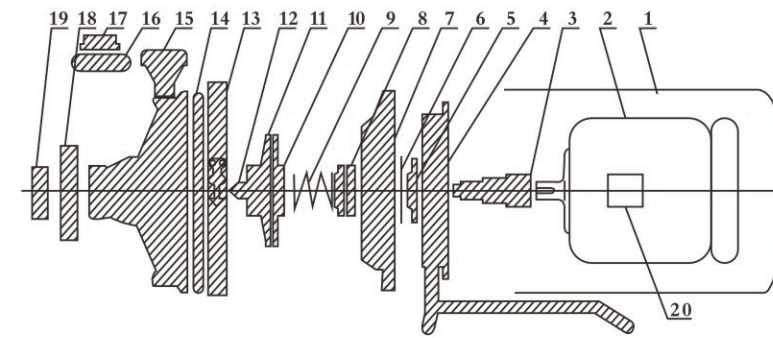

BAW-150型不锈钢卫生泵结构图

结构零件号 Structure Part Number

1	电机外封罩 Motor outer cover	2	电动机 Motor
3	连接轴 Connecting shaft	4	脚架 Tripod
5	密封垫片 Sealing gasket	6	橡胶密封圈 Rubber sealing ring
7	内底座 Neijingzuo	8	机械密封圈 Mechanical seal ring
9	弹簧 Spring	10	内叶轮 Inner impeller
11	外叶轮 Outer impeller	12	螺盖 Screw cap
13	泵头卡箍 Pump head clamp	14	橡胶密封圈 Rubber sealing ring
15	外泵头 External pump head	16	出口螺母 Outlet nut
17	出口接头 Sunrise connector	18	进口螺母 Inlet nut
19	进口接头 Inlet connector	20	电缆线 Cable line

技术参数 Technical Parameter

型号 Model	流量(t/h) flow	扬程(m) Lift	进出口径(mm) Inlet And Outlet Diameter	功率(kw) Power	外形尺寸(mm) Overall dimension	重量(kg) Weight
BAW-90	1	10	25	0.37	380x200x280	16
BAW-120	3	18	38/32	0.75	420x220x320	22
BAW-150	5	24	38	1.5	500x260x370	35
BAW-150	10	24	51/38	2.2	520x260x370	38
BAW-165	15	24	51	3	580x270x400	45
BAW-165	20	24	51	4	600x270x420	48

不锈钢自吸泵

Stainless steel self-priming pump



本公司生产的ZXB系列自吸泵，具有结构紧凑、外形美观、重量轻、操作方便等优点。泵体与液体接触部分均采用SUS304或SUS316L优质材料冷加工制成，对酸、碱、盐溶液均有很好的耐腐蚀能力，很适应输送各种酒类、制药、饮料、汽水、牛奶、食醋、食用植物油等液体。为单程自吸在间断输送时不需要每次采用灌引液体，并能与过滤机械配套使用。

ZXB series self-priming pumps produced by our company have the advantages of compact structure, beautiful appearance, light weight, convenient operation, etc. The pump body and liquid contact parts are made of SUS304 or SUS316L high-quality materials by cold processing, which have good corrosion resistance to acid, alkali and salt solutions, and are very suitable for conveying various liquids such as alcohol, pharmacy, beverages, soda, milk, vinegar, edible vegetable oil, etc. It is unnecessary to inject liquid every time for one-way self-priming in intermittent transportation, and it can be used together with filtering machinery.

技术参数 Technical Parameter

型号 Model	流量(m ³ /h) flow	扬程(m) Lift	吸程(m) Suction head	进出口径(mm) Inlet And Outlet Diameter	转速(r/min) Rotating Speed	电机功率(kw) Power	重量(kg) Weight
ZXB-3T-16M	3	16	3	32	2840	0.75	28
ZXB-3T-20M	3	20	3	32	2840	1.1	29
ZXB-5T-24M	5	24	3-4	38	2840	1.5	42
ZXB-10T-24M	10	24	3-4	51/38	2840	2.2	45
ZXB-15T-24M	15	24	3-4	51	2840	3	58
ZXB-20T-24M	20	24	3-4	51	2840	4	62
ZXB-30T-24M	30	24	3-4	63/51	2840	5.5	80
ZXB-30T-35M	30	35	4	63/51	2840	7.5	88

不锈钢卫生级自吸泵

Stainless steel sanitary self-priming pump



卫生级自吸泵是特别设计用来处理含有一部分气体的流体物料。此类泵可广泛应用于食品、化工、制药及类似要求的应用场合。特别是在(CIP)就地清洗系统中作回流泵。

Sanitary self-priming pump is specially designed to handle fluid materials containing part of gas. These pumps can be widely used in food, chemical, pharmaceutical and similar applications. Especially, it is used as reflux pump in CIP (CIP) cleaning in place system.

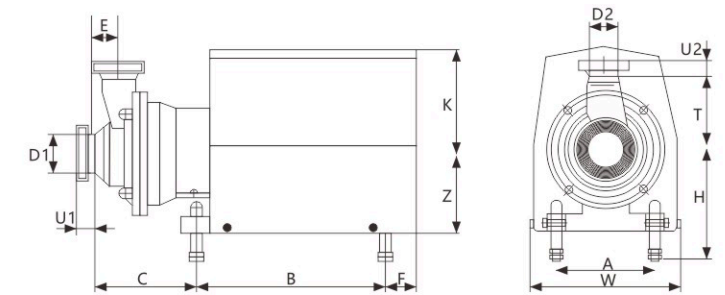

技术参数 Technical Parameter

尺寸 Size	电机功率(km) Power			尺寸 Size	ISO卡箍 Clamp	ISO活接头 Union	DIN活接头 Union	SMS活接头 Union	Bs活接头 Union	DIN法兰 Flange
	4KW	5.5KW	7.5KW							
A	210	245	245	D1	51	51	51	76.1	63.5	DN80
B	280	320	320	U1	21.5	21.5	21.5	24	21.5	24
C	225	245	245	D2	51	51	51	51	51	51
E	120	120	120	U2	21.5	21.5	21.5	24	21.5	24
F	90	100	100							
H min	200	220	220							
Hmax	240	260	260							
K	210	220	220							
T	160	135	135							
W	262	312	312							
Z	120	140	140							
重量 (kg)	76	96	108							

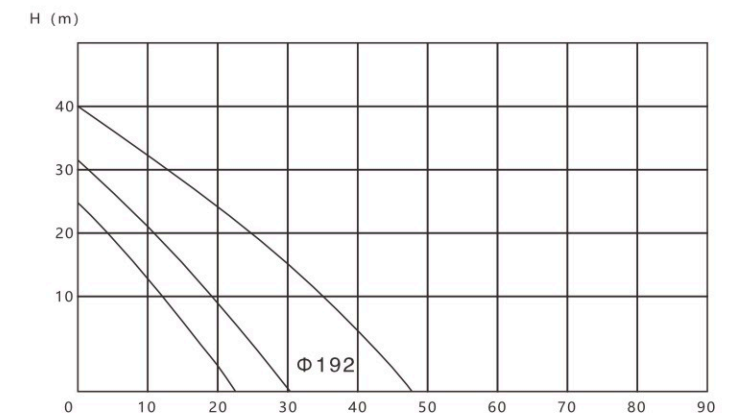

卫生自吸负压泵

Sanitary Self-priming Negative Pressure Pump



概述 Overview

JFYB系列自吸负压泵是我公司专门为客户设计开发，增加了一个偏心导轮，泵运转时，液体在偏心导轮作用下在偏心导轮腔内形成液环，从而达到实现气液混输。泵盖用不锈钢圆钢经压力机整体锻打后固溶及时效处理，经CNC加工中心一次加工成型，表面光滑，在长时间使用过程中抗腐蚀及抗气蚀性更好。泵轴我公司选用特殊不锈钢、强度高、耐腐蚀性强，两种材质在告诉运行中不易咬合，后续在维修过程中拆卸方便。叶轮采用开式设计，由CNC一次加工成型，经高精度动平衡机检测，确保泵在运转更平稳，噪音低。机封采用外置平衡型，在使用中更加洁净。整个加工过程采用圆滑过渡，无死角，特别适用于在线CIP和SIP系统中的液体输送与返回。

技术特征 Technical Characteristics

- 行业领域：食品、饮料、果汁、生物、制药、乳品、果糖、酒、醋、酱油、日用化工、水处理等。
- 使用范围：流量(≤45 m³/h)；扬程(≤30m)；压力(≤20 bar)；温度(≤180℃)。
- 机械密封：单机封(碳化硅/石墨、碳化硅/碳化硅、硬质合金/硬质合金)
- 连接方式：活接、快装、法兰(ISO、DIN、SMS、IDF、RJT、GB)
- 材质与密封：316、316L、三元乙丙、氟橡胶等。
- 电机与支撑脚：普通、防爆(电压可选)，可调支撑脚。

The JFYB series self-priming negative pressure pump is specially designed and developed by our company for customers, with the addition of an eccentric guide wheel. During pump operation, the liquid forms a liquid ring in the eccentric guide wheel cavity under the action of the eccentric guide wheel, thereby achieving gas-liquid mixed flow. The pump cover is made of stainless steel round steel, which is forged and processed by a rotary press machine, and then subjected to solid solution and aging treatment. It is processed and formed in one go by a CNC machining center, with a smooth surface and better corrosion and cavitation resistance during long-term use. Our company uses special stainless steel for the pump shaft, which has high strength, hardness, and strong corrosion resistance. Both materials are not easy to bite during operation and are easy to disassemble during maintenance. The impeller adopts an open design and is formed by CNC machining in one go. It is tested by a high-precision dynamic balancing machine to ensure that the pump runs more smoothly and has low noise. The machine seal adopts an external balanced type, which is cleaner in use. The entire processing process adopts smooth transitions and no dead corners, which is particularly suitable for liquid transportation and return in online CIP and SIP systems.

- Industry sectors: food, beverage, juice, biotechnology, pharmaceuticals, dairy products, fructose, alcohol, vinegar, soy sauce, daily chemical industry, water treatment, etc.
- Scope of use: Flow rate (≤ 45m³/h); Head (≤ 30m); Pressure (≤ 20 bar); Temperature (≤ 180 °C).
- Mechanical seal: single machine seal (silicon carbide/graphite, silicon carbide/silicon carbide, hard alloy/hard alloy)
- Connection methods: union, quick fit, flange (ISO DIN, SMS, IDF, RJT, GB)
- Material and sealing: 316, 316L, EPDM, fluororubber, etc.
- Motor and support legs: ordinary, explosion-proof (voltage optional), adjustable support legs.

卫生自吸负压泵

Sanitary Self-priming Negative Pressure Pump

型号说明 Model Description

示例 Example

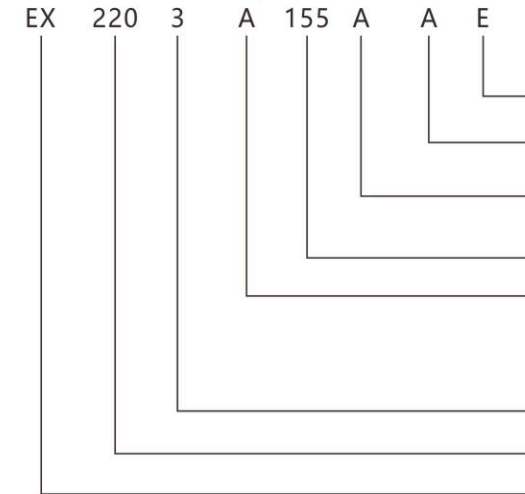

- 缺省：304材质 Material E：316材质 Material
- 泵出口连接方式：A: ISO卡箍接头 Clamp connector
B: ISO活接头 Coupling
C: DIN活接头 Coupling
D: SMS活接头 Coupling
E: DIN法兰 Flange
- 泵进口连接方式：A: ISO卡箍接头 Clamp connector
B: ISO活接头 Coupling
C: DIN活接头 Coupling
D: SMS活接头 Coupling
E: DIN法兰 Flange
- 叶轮直径 Diameter of impeller: Φ155
- 密封形式：缺省：单端面机械密封
A: 双端面机械密封
A: Double mechanical seal
- 电动机功率 Motor Power
- 机坐号 Machine number: 165.200.220.250.300
- 缺省：普通电动 Ordinary electric
BP: 变频电动 Variable frequency electric
EX: 防爆电动 Explosion-proof electric

注:

1. 随着流量的增加，扬程会相应地降低；
2. 电机属于宽频电机，适用于50Hz/60Hz的电压；
3. 若选择“标准”以外的卫生泵，请与我司联系，交货期要适当延长。

Note:

- As the flow rate increases, the head will correspondingly decrease;
- The motor belongs to broadband motors and is suitable for voltages of 50Hz/60Hz;
- If you choose a sanitary pump other than the "standard", please contact our company and extend the payment period appropriately.

机械密封 Mechanical seal

标准型 Standard type

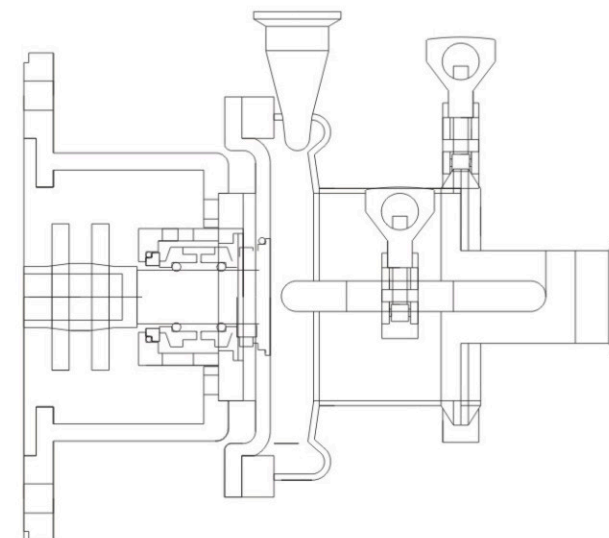

优化密封 Optimize sealing

内轴密封优化冷却和润滑密封密封腔的表面，既降低了风险“干运转”同时保证高效散热。

- 确保完美的密封面清洗。
- 维护工作：他们必须拆除泵盖，叶轮，轴密封。
- 该配件可以很容易地调整到机械轴的密封水冲洗或密封液在无菌操作下的应用。
- 双端面机械密封是一个简单的静环镜像密封；加上同轴动环件。相同的密封面和O型圈。

The internal shaft seal optimizes the cooling and lubrication of the sealing chamber surface, reducing the risk of "dry operation" while ensuring efficient heat dissipation.

Ensure perfect sealing surface cleaning.

Maintenance work: They must remove the pump cover, impeller, and shaft seal.

This accessory can be easily adjusted for the application of mechanical shaft sealing water flushing or sealing liquid under aseptic operation.

Double end mechanical seal is a simple static ring mirror seal; Add coaxial moving ring components. Same sealing surface and O-ring.

卫生自吸负压泵

Sanitary Self-priming Negative Pressure Pump

技术参数 Technical Parameter

型号 Model	电机功率 (kw) Power	扬程 (m) Lift	吸程 (m) Suction lift	流量 (m3/h) flow	进口管径 (mm) Inlet Pipe Diameter	出口管径 (mm) Outlet Pipe Diameter	转速 Rotational speed
JFYB	0.75	16	2	2	38	38	2800
JFYB	1.5	22	2.5	3-5	38	38	2800
JFYB	2.2	22—24	3	8-10	51	38	2800
JFYB	3	22—24	3	12-15	51	38	2800
JFYB	4	24	3	16-20	51	51	2800
JFYB	5.5	24	3	22-25	51	51	2800
JFYB	7.5	24	4	25-30	51	51	2800
JFYB	11	28	4	30-40	51	51	2800
JFYB	15	28	4	40-50	89	63	2800

材质 Material	流体性质(上限) Liquid conditions(max)			备注 Remark	
	温度 Temp	颗粒 Slurry	粘度 Viscosity		
石墨-碳化硅 Carbon-Ceramic	1	-10~120°C	≤0.3%	≤300cp	必须带外部冷却 Quenching(outside cooling) is required
碳化硅-碳化硅 Ceramic-Ceramic	1	-10~60°C	0.3~1%	≤300cp	
	2	>60°C	0.3~1%	≤300cp	
超硬合金-超硬合金 Cemented Carbide	1	-10~60°C	0.3~0.8%	≤250cp	
	2	>60°C	0.3~0.8%	≤250cp	

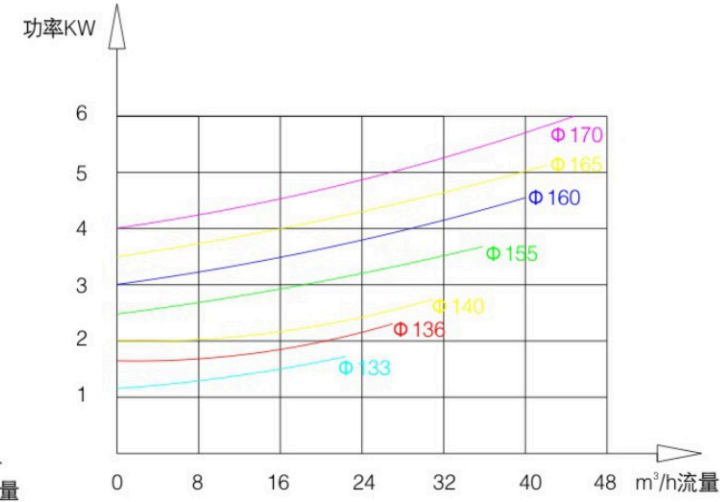
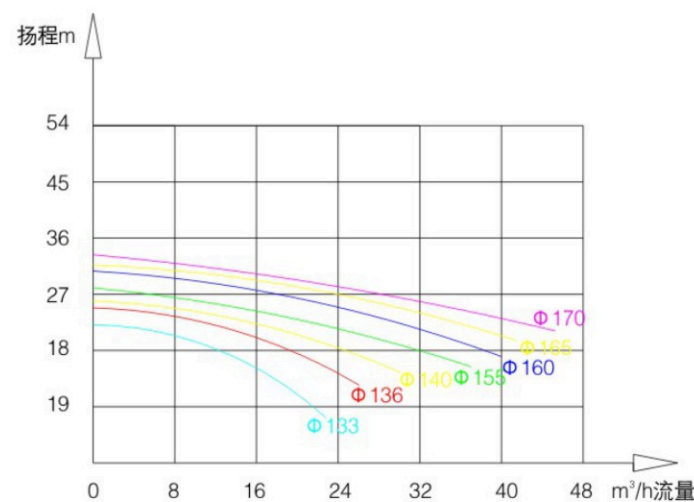

卫生自吸负压泵

Sanitary Self-priming Negative Pressure Pump

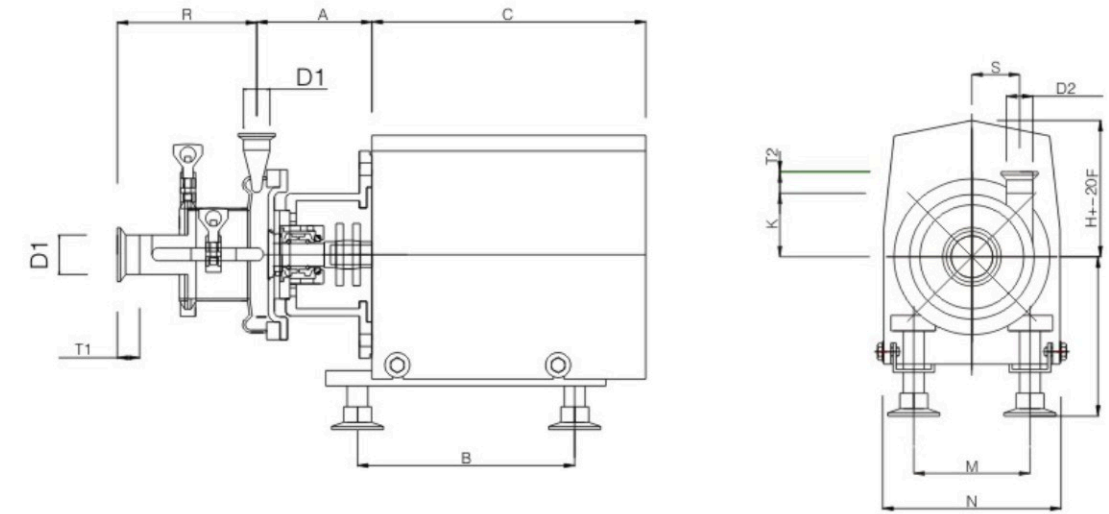

尺寸名称 Name of size	电机功率 The motor power					
	1.5KW	2.2KW	3KW	4KW	5.5KW	7.5KW
A	125	125	140	140	160	160
B	209	237	280	280	300	300
C	300	320	380	380	450	450
F	190	217	241	241	268	268
K	140	140	155	155	200	200
H	150	150	160	172	192	192
R	135	135	140	140	150	150
S	60	60	70	70	85	85
M	163	193	202	202	240	240
N	210	230	260	260	310	310
D1	Φ38	Φ51	Φ51	Φ51	Φ51	Φ63
D2	Φ38	Φ38	Φ38	Φ51	Φ51	Φ51
T1	28.5	28.5	28.5	28.5	28.5	28.5
T2	21.5	21.5	21.5	21.5	21.5	21.5

注: 1.此表尺寸T以快装为标准、活接、法兰T尺寸会有偏差、以实际为准。
2.此表尺寸C、F以普通电机为标准、变频、防爆电机C、F尺寸会有偏差、以实际为准。

Note: 1. The size T in this table is based on quick installation standards, and there may be deviations in the dimensions of flexible joints and flange T. The actual size shall prevail.
2. The size of this table is C F is based on ordinary motors, with variable frequency and explosion-proof motors There may be deviations in the F size, please refer to the actual situation.

不锈钢回程泵

Stainless steel return pump



不锈钢自吸泵是消化吸收了国外同类产品的优点，测绘并改进后设计的，结构紧凑合理，制造精密。自吸泵部分材料均为耐酸不锈钢制成（国际标准AISI316），耐酸碱腐蚀特性，尤为显著，符合食品卫生要求。

不锈钢自吸泵特性在于能输送混有空气或泡沫的液体，甚至能在只有空气的泵腔内照样自行输送。

该泵是通过对空气的压缩，使泵腔内最高能产生0.6的负压在流体行业被广泛用于液体的自吸输送泵。特别是用在CIP清洗系统，将罐内和CIP返回管路里的液体自吸输送，使管道保持无积水。

The stainless steel self-priming pump has digested and absorbed the advantages of similar foreign products. It is designed after mapping and improvement, with compact and reasonable structure and precise manufacturing. Some materials of the self-priming pump are made of acid resistant stainless steel (international standard AISI316), which is particularly resistant to acid and alkali corrosion and meets the food hygiene requirements. The characteristic of stainless steel self-priming pump is that it can transport liquid mixed with air or foam, even in the pump chamber with only air.

The pump is a self-priming pump for liquid in the fluid industry, which can generate a maximum negative pressure of 0.6 in the pump chamber by compressing the air. Especially, it is used in CIP cleaning system to self-priming and transport the liquid in the tank and CIP return pipeline to keep the pipeline free of water.

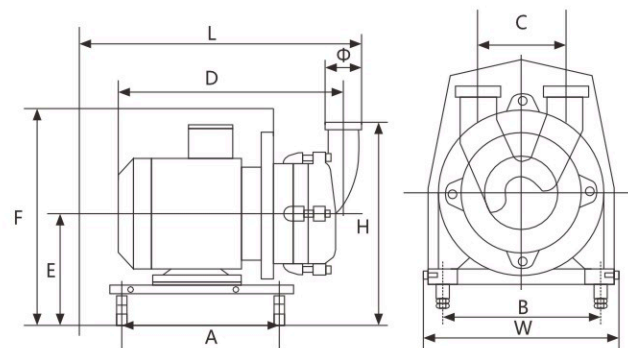

技术参数 Technical Parameter

序号 Serial No	规格 Specification	电机功率 Motor power	A	B	C	D	E	F	H	L	W	进口 Inlet	出口 Outlet
1	CIP	4KW	280	190	122	460	207	420	390	550	262	Φ51	Φ51
2	CIP	1.5W	280	160	122	460	180	355	340	520	212	Φ51	Φ51

型号 Model	流量 Flow	扬程 Lift	功率 Power	进口/出口 Inlet/Outlet	转速 r/min
CIP	3-10T	16M	1.5W	Φ51	1420
CIP	15-20T	24M	4KW	Φ51	1420

不锈钢水粉混合机

Stainless steel water powder mixer

本固液混合机由主体与离心泵水轮构成，二者垂直安装。通过一个双层壁管道将液态物与固态物分别抽吸进去，避免了在进入主体部分前凝结成块。液体高速进入混合机主体，在水轮中心产生真空，以吸入固态物。固态物通过在斗口罐下方的阀门调节均匀吸入。设计简洁、功能多样。可以迅速、均匀地混合多种固态物，不与空气接触。充分混合，产品再循环。某些情况下，可以使用“联机”不必再循环。卫生设计，快装连接，拆装方便。清洗与消毒时不需拆卸设备。机械闭阀，内部保持卫生。40°标准斗口罐。本设备专为乳品、饮料企业设计，用于混合固态物与液态物，生产糖浆、山梨糖醇、葡萄糖、乳糖及其副产品；奶粉还原；把可可粉或白砂糖溶入牛奶；溶解乳清粉；面粉与淀粉溶于水；制作盐水；预混酸奶和其他奶制品。

This solid-liquid mixer consists of a main body and a centrifugal pump water wheel, which are installed vertically. The liquid and solid substances are pumped in separately through a double walled pipeline, avoiding condensation into blocks before entering the main body. The liquid enters the main body of the mixer at high speed, creating a vacuum in the center of the water turbine to suck in solid substances. Solid matter is evenly sucked in through a valve located below the bucket. The design is simple and diverse in functionality. It can quickly and evenly mix various solid substances without coming into contact with air. Fully mix and recycle the product. In some cases, 'online' can be used without the need for recycling. Hygienic design, quick installation and connection, convenient disassembly and assembly. There is no need to disassemble equipment for cleaning and disinfection. Mechanically close the valve and maintain cleanliness internally. 40° standard bucket mouth tank. This equipment is designed specifically for dairy and beverage enterprises to mix solid and liquid substances, and produce syrup, sorbitol, glucose, lactose, and their by-products; Milk powder reduction; Dissolve cocoa powder or white sugar into milk; Dissolved whey powder; Flour and starch dissolve in water; Making saltwater; Pre mixed yogurt and other dairy products.



技术参数 Technical Parameter

名称/规格 Name/specification	KTRL-A-10	KTRL-A-20	KTRL-A-30
流量范围 Capacity	10T/H	20T/H	30T/H
叶轮直径 Impeller diameter	Φ160mm	Φ170mm	Φ180mm
进出液口径 Liquid inlet and outlet diameter	Φ38mm	Φ51mm	Φ63mm
最大工作压力 Max.work pressure	0.3Mpa	0.3Mpa	0.3Mpa
吸取温度 Absorbing temperature	≤80℃	≤80℃	≤80℃
电机功率 Motor power	3.0Kw	5.5Kw	7.5Kw
外形尺寸 Dimension	735x500x1005mm	800x500x1200mm	800x500x1300mm
机器重量 Weight	110kg	130kg	185kg

不锈钢转子泵

Stainless steel rotor pump

本公司生产的KZB3A系列不锈钢凸轮转子泵，属容积式泵。输送流量也可方便用转速控制流量，转速一般在200rpm~600rpm之间，可输送高粘度的液体高达1000000CP。其独特的工作原理在高温的物料下大显身手，并且能够保证物料在输送过程中不被破坏。所有与物料接触的零件符合卫生级不锈钢标准SUS304、316L材质加工而成，满足食品业、制药业、化工业、染发剂、糖水、化妆品、油漆、疫苗输送等高浓度的物料。

KZB3A series stainless steel cam rotor pump produced by our company is a positive displacement pump. It is also convenient to control the flow by rotating speed. The rotating speed is generally between 200rpm~600rpm, and the liquid with high viscosity can be transported up to 1000000CP. Its unique working principle shows its strength under the high temperature materials, and can ensure that the materials will not be damaged in the transportation process. All parts in contact with materials are made of SUS304 and 316L stainless steel, which meet the requirements of high concentration materials for food industry, pharmaceutical industry, chemical industry, hair dye, sugar solution, cosmetics, paint, vaccine delivery, etc.

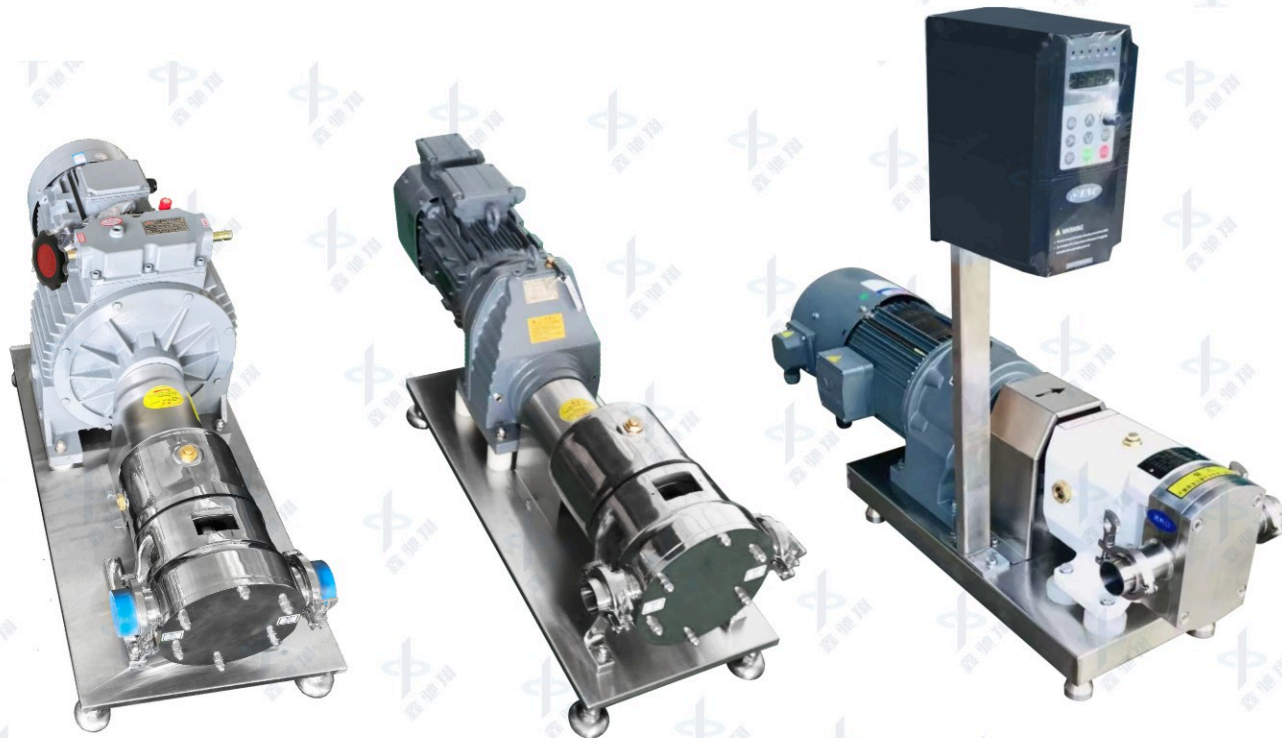

不锈钢转子泵

Stainless steel rotor pump



三叶转子 Three Blade Rotor

为应用较广泛的转子形式广泛使用在各种行业的各种粘稠物料的输送中，是标配的配置。

The rotor, which is widely used in various industries, is a standard configuration for conveying various viscous materials.



蝶形转子 Butterfly Rotor

蝶形转子通常适用于输送馅料或输送含有固体颗粒的粘稠物料。输送过程中会有极小部分的颗粒会被破碎。

Butterfly rotor is usually suitable for conveying filling materials or viscous materials containing solid particles. During transportation, a small part of particles will be broken.



单叶转子 Single Blade Rotor

为解决输送含有大颗粒固体物料配置专用，其独特的形状和曲线使其在输送含有大颗粒物料时其他形式的泵更具优势，并能够在输送过程中有效地避免颗粒的破损。

In order to solve the problem of special configuration for conveying solid materials containing large particles, its unique shape and curve make it more advantageous for other types of pumps when conveying solid materials containing large particles, and can effectively avoid particle damage in the conveying process.



多叶转子 Multiblade Rotor

当转子叶片超过三叶后其容积量因转子叶片的增加而减少，转子叶片越多，容积量则越少，多叶转子在输送物料时稳定性相对有所提高，但在输送过程中容易破碎颗粒物料。

When the rotor blade exceeds three blades, its volume decreases due to the increase of the rotor blade. The more rotor blades, the less the volume. The stability of the multi blade rotor is relatively improved when conveying materials, but it is easy to break granular materials in the conveying process.

技术参数 Technical Parameter

型号 Model	每百转排量(L) Displacement per 100 revolutions	建议调速范围(r/min) Recommended speed regulation range	对应流量(L / H) Corresponding flow	电机功率(kw) Power
KZB3A-3	3L	200-500	300-800	0.55
KZB3A-6	6L	200-500	650-1600	0.75
KZB3A-8	8L	200-500	850-2160	1.5
KZB3A-12	12L	200-500	1300-3200	2.2
KZB3A-20	20L	200-500	2100-5400	3
KZB3A-30	30L	200-500	3200-6400	4
KZB3A-36	36L	200-400	3800-7600	4
KZB3A-52	52L	200-400	5600-11000	5.5
KZB3A-70	70L	200-400	7100-14000	7.5
KZB3A-78	78L	200-400	9000-18000	7.5
KZB3A-100	100L	200-400	11000-22000	11
KZB3A-135	135L	200-400	15000-30000	15
KZB3A-160	160L	200-400	17000-34000	18.5
KZB3A-200	200L	200-400	21600-43000	22

不锈钢乳化机

Stainless steel emulsion machine



本公司生产的JRH型高剪切均质乳机，是一种立式安装的乳化设备。定转子设计为爪式耦合机构，物料从主机上部与下部同时吸入，并向四周离心抛出。剪切均质效率成倍提高，避免釜内上部物料易产生死角问题，该产品适用于在各种大小反应釜，普通容器上的均质、精细、乳化小容量乳化也可以转移吊芯使用。与物料接触选用优质不锈钢SUS304、316L材质。

The JRH high shear homogenizing milk machine produced by our company is a vertically installed emulsification equipment. The stator and rotor are designed as claw type coupling mechanism. Materials are sucked in from the upper and lower parts of the main engine at the same time, and are thrown out centrifugally around. The shear homogenization efficiency is doubled to avoid the problem that the upper materials in the kettle are easy to produce dead angle. This product is suitable for homogenization, fine, small volume emulsification on various reaction kettles and ordinary containers, and can also be used for transferring suspended cores. High quality stainless steel SUS304 and 316L shall be selected for material contact.

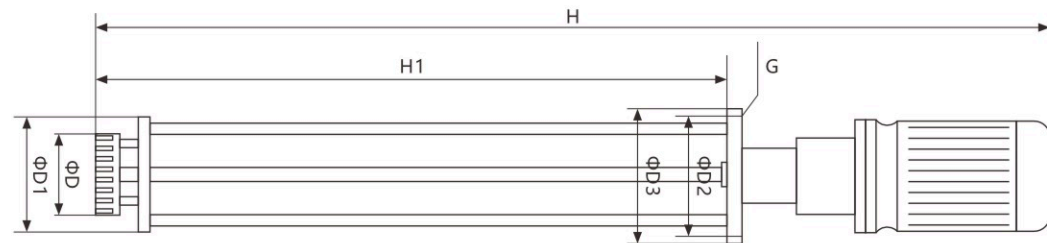

技术参数 Technical Parameter

型号 Model	处理量L Processing Capacity	功率KW Power	转速rpm Speed	D	D1	H1	D2	D3	H	G
JRH65	5~10	0.75	2800	76	120	300	140	160	600	4×Φ10
JRH90	10~50	1.5	2800	105	140	455	180	200	950	4×Φ10
JRH100	50~100	2.2	2800	116	160	650	190	220	1005	4×Φ12
JRH120	100~300	4	2800	141	195	725	225	260	1203	4×Φ14
JRH140	200~800	7.5	2800	158	235	833	265	300	1520	4×Φ16
JRH160	300~1000	11	2800	184	235	833	265	300	1655	4×Φ16
JRH180	500~1500	18.5	2800	200	260	1200	300	350	2065	8×Φ18
JRH200	800~2000	22	1400	220	260	1200	300	350	2130	8×Φ18
JRH220	1000~3000	30	1400	250	295	1355	350	400	2525	8×Φ20
JRH240	1500~5000	37	1400	270	295	1395	350	400	2585	8×Φ20
JRH270	2000~8000	55	1400	330	380	1638	450	500	2995	8×Φ20
JRH290	3000~10000	75	1400	350	395	1648	450	500	3050	12×Φ20

不锈钢均质乳化泵

Stainless steel homogeneous emulsion pump



本公司生产的JRL均质乳化泵是一种集混合、分散、破碎、精细、解聚、均质、乳化为一体的高效型混合精细乳化泵产品，乳化泵系列混合精细乳化泵主要工作部分由定子、转子组成。乳化泵定子在转子快速运转的离心力和液力作用下，乳化泵将物料进行强烈剪切、离心挤压、撞击破裂、液层摩擦、湍流均匀等综合作用，从而使不相容的固相、液相、气相等各种介质下瞬间均匀精细、分散乳化。经过往复循环，使原来产品达到稳定的高品质产品。物料接触选用优质不锈钢SUS304、316L再经硬化处理，经久耐用。

JRL homogeneous emulsion pump produced by our company is an efficient mixed fine emulsion pump product integrating mixing, dispersion, crushing, fine, depolymerization, homogenization and emulsification. The main working parts of the mixed fine emulsion pump series are composed of stator and rotor. Under the centrifugal force and hydraulic force of the rotor's rapid operation, the emulsion pump stator performs a comprehensive action of intense shearing, centrifugal extrusion, impact fracture, liquid layer friction, turbulence uniformity, etc., so as to make the incompatible solid, liquid, gas and other media uniformly fine and disperse emulsification instantly. Through the reciprocating cycle, the original products can reach stable high quality products. High quality stainless steel SUS304 and 316L are selected for material contact and then hardened for durability.

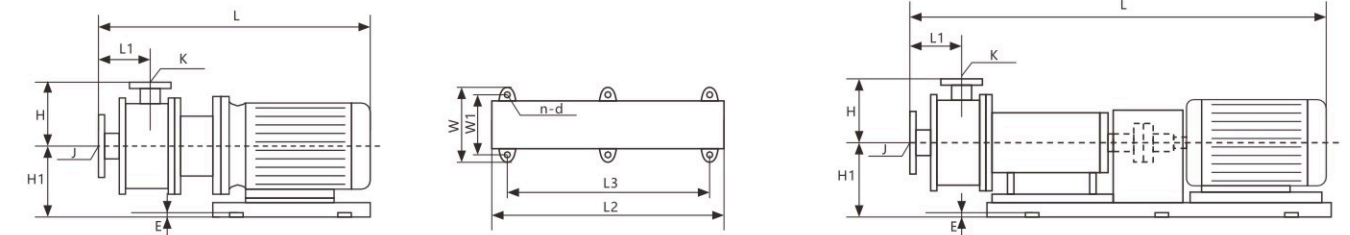

技术参数 Technical Parameter

型号 Model	流量(t/h) flow	功率kw Power	转速rpm Speed	L	L1	H	H1	E	L2	L3	W	W1	J DN	K DN	L	n-d
JRL-65	≤1.5	1.5	2800	575	90	180	150	20	300	220	280	250	40	32	298	4×Φ14
JRL-100	≤3	2.2	2800	575	90	180	150	20	300	220	280	250	40	32	298	4×Φ14
JRL-130	≤4	3.0	2800	575	90	180	150	20	300	220	280	250	40	32	298	4×Φ14
JRL-140	≤5	5.5	2800	743	137	224	182	25	400	320	375	346	50	40	357	4×Φ14
JRL-165	≤8	7.5	2800	743	137	224	182	25	400	320	375	346	50	40	357	4×Φ14
JRL-180	≤12	11	2800	864	124	250	190	25	480	405	420	380	65	50	406	4×Φ14
JRL-185	≤18	15	2800	916	124	250	190	25	480	405	420	380	65	50	406	4×Φ14
JRL-200	≤25	22	2800	986	124	270	190	15	550	475	450	410	65	50	406	4×Φ20
JRL-210	≤35	30	2800	1400	150	300	230	15	1300	1220	550	480	80	65	250	6×Φ20
JRL-230	≤50	45	2800	1485	150	325	240	15	1300	1220	590	520	100	80	260	6×Φ20
JRL-245	≤75	55	2800	1800	150	350	250	15	1500	1420	660	580	100	80	280	6×Φ24
JRL-260	≤90	75	2800	1920	150	380	260	15	1500	1420	720	640	125	100	340	6×Φ24
JRL-275	≤110	90	2800	2050	150	380	270	15	1500	1420	720	640	125	100	350	6×Φ24
JRL-280	≤130	132	2800	2050	150	380	270	15	1500	1420	720	640	125	100	350	6×Φ24

不锈钢双螺杆泵

Stainless steel twin Screw pump

本公司生产的KJLS双螺杆泵，是现代设计技术与现代高精密加工制造技术的结晶；是生产工艺专家与设备制造业融合的新成果。特殊设计的一对螺旋系统，相互啮合，同时采用现代加工技术和手段（如电火花技术，激光切割，多联轴数控编程加工中心等），保证泵体内相对运动的双面转子不存在任何金属间的直接接触。从设计上和结构上共同保证系统运转的无接触，无磨损，从而保证设备系统的无故障，长寿命。

特殊设计的一对螺旋系统，相互啮合，它们之间形成一系列动态的空间曲面的密封面。由于螺旋的相互啮合以及螺旋与衬筒的紧密配合，在泵的吸入口和排出口之间，就会被分隔成一系列多个密封空间。随着螺旋的转动和啮合，这些密封空间在泵的吸入端连续不断形成，将吸入室中的液体封入其中，并且吸入室沿螺旋轴向连续地推移至排出端，将封闭在各个独立空间中的液体连续不断，平稳的排出，犹如螺母在螺旋回转时被不断向前推进的情形那样。这就是系列双螺旋输送泵的基本工作原理。

The KJLS double screw pump produced by the company is the crystallization of modern design technology and modern high-precision processing and manufacturing technology; It is a new result of the integration of production process experts and equipment manufacturing industry. Specially designed pair of spiral system, mesh with each other, while using modern processing technology and means (such as electric spark technology, laser cutting, multi-axis dynamic CNC programming machining center, etc.), to ensure that the pump body relative movement of the double-sided rotor without any direct contact between metals. From the design and structure to ensure the system operation of no contact, no wear, so as to ensure the equipment system trouble-free, long life.

A pair of specially designed helical systems mesh with each other, forming a series of dynamic space surface sealing surfaces between them. Due to the mesh of the helix and the tight fit of the helix with the liner, a series of multiple sealing Spaces are separated between the suction and discharge of the pump. With the rotation and meshing of the spiral, these sealed Spaces are continuously formed at the suction end of the pump, sealing the liquid in the suction chamber into it, and the suction chamber is continuously pushed along the spiral axis to the discharge end, and the liquid enclosed in each independent space is continuously and smoothly discharged, just as the nut is constantly pushed forward when the spiral is turned. This is the basic working principle of a series of double screw pump.

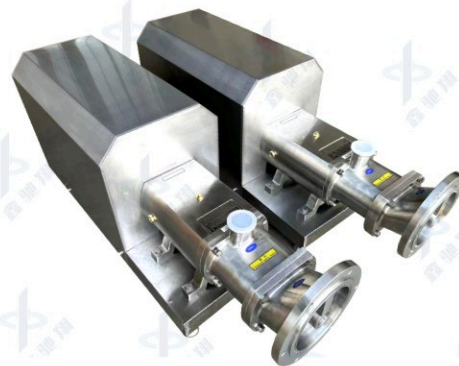
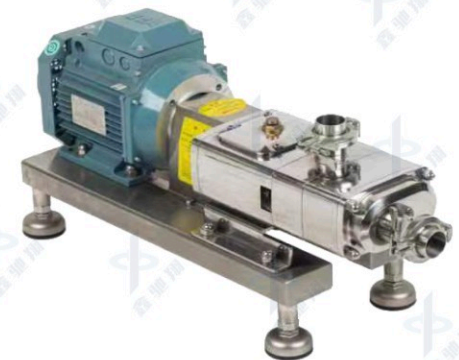

不锈钢双螺杆泵

Stainless steel twin Screw pump

KJLS系列双螺杆泵采用开放式，模块化，卫生结构设计，整个系统由泵体，传动齿轮箱，电机三个主要部分组成。采用全不锈钢卫生标准，所有和物料接触的部分都采用高等级优质304或316L卫生级不锈钢，传动部分也采用球墨，304不锈钢和铸钢三种结构，保持设备的高等级，高质量。

KJLS series double Screw pump adopts open, modular and sanitary structure design. The whole system consists of three main parts: pump body, transmission gearbox and motor. Adopting all stainless steel hygiene standards, all parts in contact with materials are made of high-grade high-quality 304 or 316L hygiene grade stainless steel, and the transmission part is also made of three structures: ductile iron, 304 stainless steel, and cast steel, to maintain the high level and quality of the equipment.

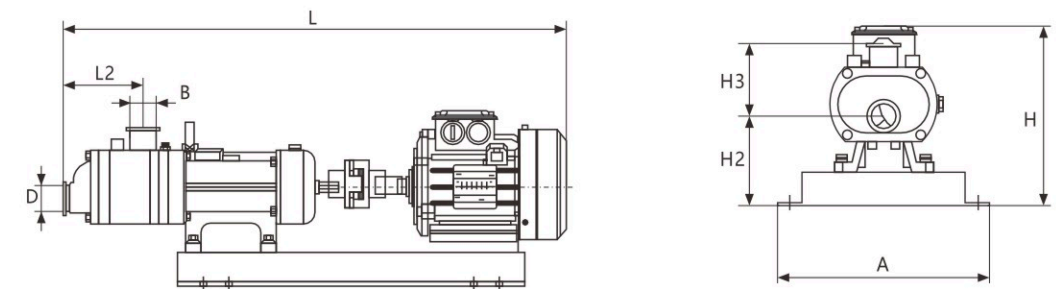

技术参数 Technical Parameter

型号 Model	A	H	L	H2	H3	L2	B	D
KJLS-60	400	330	838	200	104	162	1.5"	2"
KJLS-90	400	330	990	160	140	156	2"	2"
KJLS-110	430	385	990	207	140	192	2.5"	2.5"
KJLS-140	475	425	998	217	140	195	3"	3"
KJLS-160	480	425	1038	227	142	200	3"	3"

型号 Model	流量 L/h	进出口 mm	调节范围 r/min	压力 bar	电机功率 KW
KJLS-60	1250~3000	DN40 DN40	~960	3-9	1.5
KJLS-90	3000~7000	DN50 DN50			2.2~4
KJLS-110	4500~11000	DN65 DN65			5.5~7.5
KJLS-140	8000~20000	DN80 DN80			11~18.5
KJLS-160	15000~35000	DN80 DN80			22~30
KJLS-200	25000~50000	DN100 DN80			37~55

不锈钢正弦泵

Stainless steel sine pump

任何精品或功能良好的产品均具有简约的构造--又包括少数组件, 正弦泵亦不例外。

叶轮的正弦波造型意味着每次转动均可形成一个腔室(每次经过衬套空间时可发生4次)。通过该运动, 可“推动”或“排放”流动产品。控制刮板将泵腔分为吸入腔室和排出腔室, 保证进出口的压差。同时, 控制刮板也发挥着另一项重要作用, 即通过产品对泵轴套进行强制润滑。

正弦泵-效率卓越, 是高粘度, 超低剪切输送的有效选择。

超低剪切输送即使含有大量固体物质和易碎产品, 仍可安全无破坏性输送。

高粘度性能达到流动能力的极限, 可达4,000,000cps。

无脉冲, 平稳输送精确调节流动容积, 无干扰震动, 装料机可均匀供应稳定产品量。

正弦泵: 不使用转子、行星齿轮、活塞等装置, 而是采用了特殊制造的叶片, 叶片形状如两条正弦波曲线。同时与一个活动刮板和一个固定衬套共同动作。构成一种特殊形式的容积泵。这样可实现流体的超低剪切。无脉冲输送。即使在10bar的背压条件下(输送水), 压力计上亦不显示任何移动。

Any good or well-functioning product has a simple construction -- and a few components, Sine pumps are no exception.

The sine wave shape of the impeller means that a chamber can be formed with each rotation (up to 4 times each time it passes through the bushing space). Through this movement, mobile products can be "pushed" or "emitted". The control scraper divides the pump chamber into suction chamber and discharge chamber to ensure the pressure difference between the inlet and outlet. At the same time, the control scraper also plays another important role, that is, the forced lubrication of the pump shaft sleeve through the product.

Sinusoidal pumps - Excellent efficiency and an effective choice for high viscosity, ultra-low shear delivery.

Ultra-low shear transport Safe and non-destructive transport even with large amounts of solid material and fragile products.

High viscosity up to the limit of flow capacity, up to 4,000,000cps.

No pulse, smooth transmission accurately adjust the flow volume, no interference vibration, the charging machine can uniformly supply stable product quantity.

Sinusoidal pump: does not use rotor, planetary gear, piston and other devices, but uses a specially manufactured blade, the shape of the blade is like two sine wave curves. It also operates with a movable scraper and a fixed bushing. Constitutes a special form of positive displacement pump. This enables ultra-low shear of the fluid. No pulse transmission. Even at a back pressure of 10bar (conveying water), no movement is shown on the manometer.

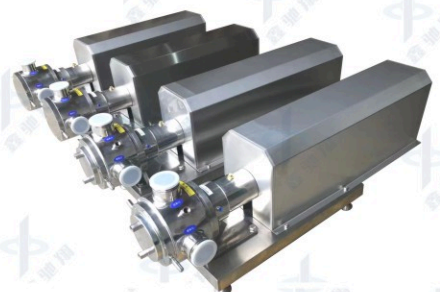
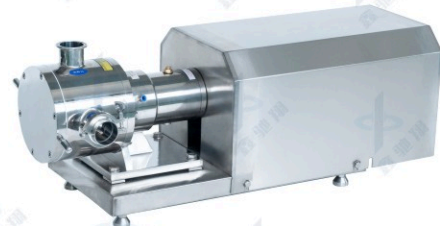

不锈钢正弦泵

Stainless steel sine pump

不锈钢制造的导轨
Guide rails made of stainless steel

不同材料制造的控制刮板, 用以分隔吸入入口和排出口, 保证出口压力。
Control scrapers made of different materials are used to separate the suction and discharge ports, ensuring outlet pressure.

根据不同的输送介质, 使用不同材料制造的衬套, 如聚酰胺(Polyamide, Peek或不锈钢)。
Bushings made of different materials, such as Polyamide, Peek, or stainless steel, are used according to different conveying media.

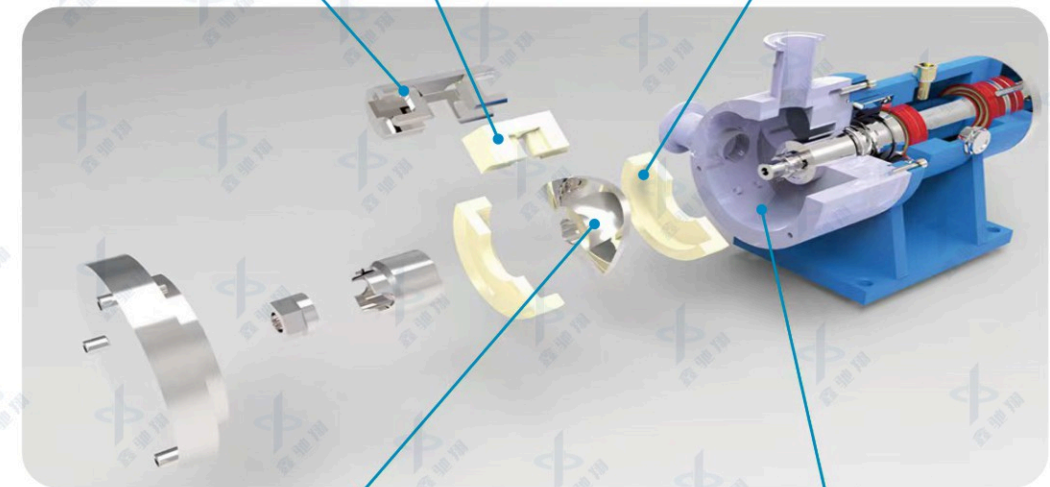

叶片由不锈钢制成, 形状如正弦波
The blades are made of stainless steel and have a sine wave shape

不锈钢制造的泵壳 (W.No.1.4571)
Pump casing made of stainless steel (W. No.1.4571)

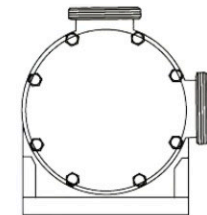
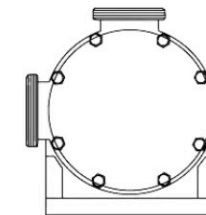
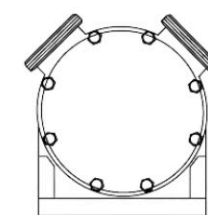

提供多种接口形式:卡箍、螺纹、法兰, 上图为可选的进出口连接方向。
Available in a variety of interface forms: clamp, thread, flange, above is the optional import and export connection direction.

技术参数 Technical Parameter

型号 Model	每转排量 Displacement per rotation (L)	进出口径 Diameter of inlet and outlet		调速范围 Range of RPM (r/min)	对应流量 Rang of flow rate (L/H)	电机功率 Electrical power	
		inch	mm			KW	HP
JTS-SP-1"	0.06	1	25	50-1000	180-3600	1.5	2
JTS-SP-2"	0.11	2	51	50-1000	330-6600	2.2	3
JTS-SP-2.5"	0.28	2.5	63	50-600	840-11800	3	4
JTS-SP-3"	0.45	3	76	50-600	1350-16200	4	5
JTS-SP-3.5"	0.75	3.5	89	50-600	2250-27000	5.5	7
JTS-SP-4"	1.05	4	102	50-600	3150-37800	7.5	10
JTS-SP-6"	2.5	6	152	50-600	7500-90000	15	20

不锈钢胶体磨

Stainless steel colloid mill



本公司生产的JM胶体磨可根据用户的特殊要求提供多功能的可空转式运作，机封与介质绝无接触，该机器密封性能良好，防止挥发性、易燃性、易爆性、高卫生及可在真空条件下工作等特点，特别适用于：香精、香料、医药、药物、石油、化工、精细化工、生物制剂、植物蛋白、动物蛋白、啤酒、食品、高校、科研实验室等领域行业使用。从而达到防爆防燃、防止加工物料有效成份的挥发或刺激工作环境和确保物料的品质纯正。可以使加工物料有效得到多循环的处理而达到理想的效果。

JM colloid mill produced by our company can provide multifunctional idling operation according to the special requirements of users. The mechanical seal has no contact with the medium. The machine has good sealing performance, and can prevent volatility, flammability, explosiveness, high sanitation, and can work under vacuum conditions. It is especially suitable for: essence, spices, medicine, drugs, petroleum, chemical industry, fine chemicals, biological agents, plant protein, animal protein, beer. It is used in food, universities, scientific research laboratories and other fields. So as to achieve explosion-proof and flameproof, prevent the volatilization of effective ingredients of processing materials or stimulate the working environment, and ensure the purity of materials. It can make the processed materials be effectively treated in multiple cycles to achieve the desired effect.

技术参数 Technical Parameter

型号 Model	加工细度um Processing Fineness	产量T/H Output	磨盘直径mm Grinding Disc Diameter	冷却水管mm Cooling Water Pipe	出口mm Outlet	进口mm Inlet	转速rpm Rotating Speed	电机功率kw Power	重量kg Weight	外形尺寸(mm) Overall dimension
JM-L50	2-50	0.01-0.1	50	-	20	30	2900	1.5	45	280*400*700
JM-L65	2-50	0.01-0.5	65	10	20	30	2900	1.5	45	280*400*700
JM-L80	2-50	0.3-1	80	12	25	57	2900	3	85	350*550*950
JM-L100	2-50	0.5-2	100	12	32	76	2900	5.5	145	400*650*980
JM-L120	2-50	1-3	120	12	32	76	2900	7.5	145	400*650*980
JM-L140	2-50	1-4	140	12	40	89	2900	7.5	170	420*700*1150
JM-F50	2-50	0.01-0.1	50	-	20	30	2900	1.5	85	550*260*720
JM-F65	2-50	0.01-0.5	65	10	20	30	2900	2.2	85	550*260*720
JM-F80	2-50	0.3-1	80	12	25	57	2900	4	145	700*320*900
JM-F100	2-50	0.5-2	100	12	32	76	2900	5.5/7.5	225	800*400*980
JM-F120	2-50	1-3	120	12	32	76	2900	7.5	225	800*400*980
JM-F140	2-50	1-4	140	12	40	89	2900	11/15	285	800*400*1100
JM-F180	2-50	2-8	180	12	40	108	2900	18.5/22	390	900*420*1200
JM-W80	2-50	0.3-1	80	12	25	57	2900	4	80	630*380*980
JM-W100	2-50	0.5-2	100	12	32	76	2900	5.5/7.5	125	680*400*580
JM-W120	2-50	1-3	120	12	32	76	2900	7.5	125	680*400*580
JM-W140	2-50	1-4	140	12	38	89	2900	11/15	150	680*400*600

卫生级不锈钢配件系列

Sanitary stainless steel accessories series



卫生级焊接弯头(45°)
Sanitary welded elbow(45°)



卫生级焊接弯头(90°)
Sanitary welded elbow(90°)



卫生级加直端焊接弯头(90°)
Sanitary welded elbow with straight ends(90°)



卫生级卡箍弯头(90°)
Sanitary clamped elbow(90°)



卫生级活接式弯头
Sanitary union-type elbow



卫生级U型三通
Sanitary "U" type tripet



卫生级快装三通
Sanitary quick-install tee



卫生级焊接三通
Sanitary welded tee



卫生级焊接四通
Sanitary welded tee



卫生级焊接大小头
Sanitary welded transition pipe



卫生级软管接头
Sanitary hose coupling



卫生级管
Sanitary Pipe-fitting

■ 本公司生产各类不锈钢管件，可承接非标定制，来图来样，材质不锈钢304、316L。

The company produces all kinds of stainless steel pipe fittings, can undertake non-standard customization, to draw samples, stainless steel 304, 316L.

卫生级阀门 Sanitary Valve



卫生级球阀
Sanitary ball valve



卫生级隔膜阀
Sanitary diaphragm valve



卫生级快装蝶阀
Sanitary quick-install butterfly valve



卫生级焊接式蝶阀
Sanitary welded butterfly valve



卫生级螺纹蝶阀
Sanitary threaded butterfly valve



卫生级三片式蝶阀
Sanitary three-piece butterfly valve



卫生级止回阀
Sanitary check valve



卫生级气动蝶阀
Sanitary pneumatic butterfly valve



卫生级气动蝶阀
Sanitary pneumatic butterfly valve

■ 本公司生产各类不锈钢球阀、蝶阀、隔膜阀、安全阀等各类阀门。承接非标定制。

The company produces all kinds of stainless steel ball valves, butterfly valves, diaphragm valves, safety valves and other valves. Undertake non-standard customization.

卫生级卡箍、垫圈、活接头 Sanitary Hoop, Gasket, Movable Fitting



DIN卫生级活接头
DIN sanitary movable fitting

SMS卫生级活接头
SMS sanitary movable fitting

IDF卫生级活接头
IDF sanitary movable fitting

卫生级盲螺母
Sanitary blind cap

由任技术参数

规格: 1"-6"DIN15-DIN150

材质: 采用 AISI304、316 或 AISI316L

光洁度: 内表面机械抛光 $Ra \leq 0.4 \sim 0.8 \mu m$, 外表面亮光或亚光 ($Ra \leq 0.8 \mu m$)。

Union Technical Parameter

Size: 1"-6"DIN15-DIN150

Material: Adopts AISI304, 316 or AISI 316L

Fineness: Inner surface mechanical polish $Ra \leq 0.4 \sim 0.8 \mu m$, outer surface gloss polished or dull polished $Ra \leq 0.8 \mu m$.



■ 本公司生产各类不锈钢活接头、卡箍、垫圈、垫片、四氟垫圈等，可承接非标定制。

The company produces all kinds of stainless steel joints, clamps, gaskets, gaskets, PTFE gaskets, etc., can undertake non-standard customization.